 **CRISTAL**

SMART

EN

**READY COOK
BUILT-IN OVEN**

Dear Customer,

We take offering quality products more than your expectation as goal, offers you the products produced in modern facilities carefully and particularly tested for quality.

Your manual is prepared in order to help you to use your appliance that is manufactured by the most recent technology, with confidence and maximum efficiency.

Before use of your appliance, carefully read this guide that includes the basic information for right and safe installation, maintenance and use. Contact to the nearest Authorized Service for mounting of your product.



Contents

- 1- Presentation and size of product .**
 - 2- Warnings**
 - 3- Preparation for installation and use**
 - 4- Using the oven . .**
 - 5- Cleaning and maintenance of your product**
 - 6- Service and Transport**
-
- 

PART 1: PRESENTATION AND SIZE OF PRODUCT

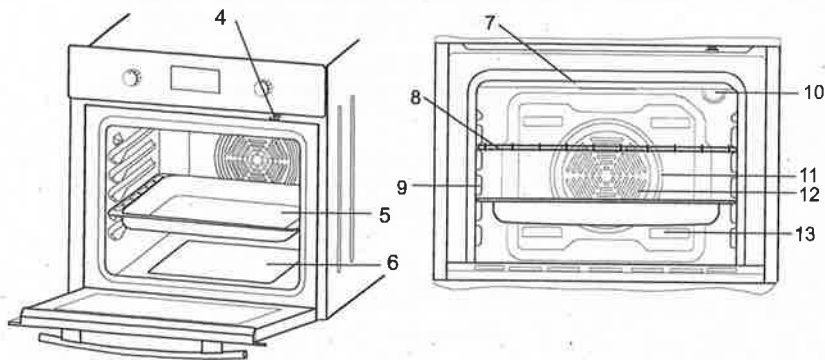
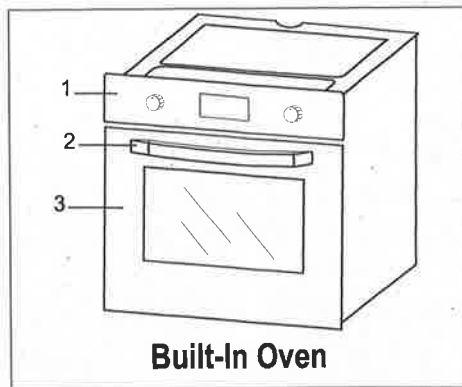

LIST OF COMPONENTS :

1- Control panel

2- Handle

3- Oven Door

4- Child Lock

5- Tray

6- Lower Heating Element (behind the plate)

7- Upper Heating Element (behind the plate)

8- Wire Grill

9- Racks

10- Oven Light

11- Turbo Heating Element(behind the plate)

12- Fan (behind the plate)

13- Air Outlet Shutters

PART 2 SAFETY WARNINGS

READ THESE INSTRUCTIONS CAREFULLY AND COMPLETELY BEFORE USING YOUR APPLIANCE, AND KEEP IT IN A CONVENIENT PLACE FOR REFERENCE WHEN NECESSARY.

THIS MANUAL IS PREPARED FOR MORE THAN ONE MODEL IN COMMON. YOUR APPLIANCE MAY NOT HAVE SOME OF THE FEATURES THAT ARE EXPLAINED IN THIS MANUAL. PAY ATTENTION TO THE EXPRESSIONS THAT HAVE FIGURES, WHILE YOU ARE READING THE OPERATING MANUAL.

General Safety Warnings

- This appliance can be used by children aged from 8 years and above and persons with reduced physical, sensory or mental capabilities or lack of experience and knowledge if they have been given supervision or instruction concerning use of the appliance in a safe way and understand the hazards involved. Children shall not play with the appliance. Cleaning and user maintenance shall not be made by children without supervision.
- **WARNING:** The appliance and its accessible parts become hot during use. Care should be taken to avoid touching heating elements. Children less than 8 years of age shall be kept away unless continuously supervised.
- **WARNING:** Danger of fire: do not store items on the cooking surfaces.
- **WARNING:** If the surface is cracked, switch off the appliance to avoid the possibility of electric shock.
- The appliance is not intended to be operated by means of an external timer or separate remote-control system.

- During use, the appliance becomes hot. Care should be taken to avoid touching heating elements inside the oven.
- During use, handles held for short periods in normal use can get hot.
- Do not use harsh abrasive cleaners or sharp metal scrapers to clean the oven door glass and other surface since they can scratch the surface, which may result in shattering of the glass or damage to the surface.
- Do not use steam cleaners for cleaning the appliance.
- **WARNING:** Ensure that the appliance is switched off before replacing the lamp to avoid the possibility of electric shock.
- **CAUTION:** Accessible parts may be hot when the cooking or grilling is in use. Young children should be kept away.
- Your appliance is produced in accordance with all applicable local and international standards and regulations.
- Maintenance and repair work must be made only by authorized service technicians. Installation and repair work that is carried out by unauthorized technicians may endanger you. It is dangerous to alter or modify the specifications of the appliance in any way.
- Prior to installation, ensure that the local distribution conditions (nature of the gas and gas pressure or electricity voltage and frequency) and the requirements of the appliance are compatible. The requirements for this appliance are stated on the label.
- **CAUTION:** This appliance is designed only for cooking food and is intended for indoor domestic household use only and should not be used for any other purpose or in any other application, such as for non-domestic use or in a commercial environment or room heating.
- Do not try to lift or move the appliance by pulling the door handle.
- All possible security measures have been taken to ensure your safety. Since the glass may break, you should be careful while cleaning to avoid scratching. Avoid hitting or knocking on the glass with accessories.

- Ensure that the supply cord is not wedged during the installation. If the supply cord is damaged, it must be replaced by the manufacturer, its service agent or similarly qualified persons in order to prevent a hazard.

- While the oven door is open, do not let children climb on the door or sit on it.

Installation Warnings

- Do not operate the appliance before it is fully installed.

- The appliance must be installed by an authorized technician and put into use. The producer is not responsible for any damage that might be caused by defective placement and installation by unauthorized people.

- When you unpack the appliance, make sure that it is not damaged during transportation. In case of any defect; do not use the appliance and contact a qualified service agent immediately. As the materials used for packaging (nylon, staplers, styrofoam...etc) may cause harmful effects to children, they should be collected and removed immediately.

- Protect your appliance against atmospheric effects. Do not expose it to effects such as sun, rain, snow etc.

- The surrounding materials of the appliance (cabinet) must be able to withstand a temperature of min 100°C.

During usage

- When you first run your oven a certain smell will emanate from the insulation materials and the heater elements. For this reason, before using your oven, run it empty at maximum temperature for 45 minutes. At the same time you need to properly ventilate the environment in which the product is installed.

- During usage, the outer and inner surfaces of the oven get hot. While opening the oven door, step back to avoid the hot steam coming out of the oven. There may be a risk of burns.

- Do not put flammable or combustible materials, in or near the appliance when it is operating.

- Always use oven gloves to remove and replace food in the oven.

- Do not leave the cooker while cooking with solid or liquid oils. They may catch fire on condition of extreme heating. Never pour water on to flames that are caused by oil. Cover the saucepan or frypan with its cover in order to choke the flame that has occurred in this case and turn the cooker off.

- If you will not use the appliance for a long time, plug it off. Keep the main control switch off. Also when you do not use the appliance, keep the gas valve off.

- Make sure the appliance control knobs are always in the "0" (stop) position when it is not used.

- The trays incline when pulled out. Be careful not to let hot liquid spill over.

- When the door or drawer of the oven is open, do not leave anything on it. You may unbalance your appliance or break the cover.

- Do not put heavy things or flammable or ignitable goods (nylon, plastic bag, paper, cloth...etc) into the drawer. This includes cookware with plastic accessories (e.g. handles).

- Do not hang towels, dishcloths or clothes from the appliance or its handles.

During cleaning and maintenance

- Always turn the appliance off before operations such as cleaning or maintenance. You can do it after plugging the appliance off or turning the main switches off.

- Do not remove the control knobs to clean the control panel.

**TO MAINTAIN THE EFFICIENCY AND SAFETY OF YOUR APPLIANCE, WE
RECOMMEND YOU ALWAYS USE ORIGINAL SPARE PARTS AND TO CALL ONLY OUR
AUTHORIZED SERVICE AGENTS IN CASE OF NEED.**

PART 3: PREPARATION FOR INSTALLATION AND USE

Manufactured with best quality parts and materials, this modern, functional and practical oven will meet your needs in all respects. Make sure to read the manual to obtain successful results and not to experience any problems in the future. The information given below contain rules that are necessary for correct positioning and service operations. They should be read without fail especially by the technician who will position the appliance.

CONTACT THE AUTHORIZED SERVICE FOR INSTALLATION OF YOUR OVEN!

3.1. CHOOSING A PLACE FOR THE OVEN

There are several points to pay attention to when choosing a place for your oven. Make sure to take into account our recommendations below in order to prevent any problems and dangerous situations, which might occur later!

- When choosing a place for the oven, attention should be paid that there are no flammable or combustible materials in the close vicinity, such as curtains, oil, cloth etc. which quickly catch fire.
- Furnitures surrounding the oven must be made of materials resistant to heat more than 50 C° of the room temperature.
- Required changes to wall cabinets and exhaust fans above the built-in combined product as well as minimum heights from the oven board are shown in Figure 1. Accordingly, the exhaust fan should be at a minimum height of 65 cm from the hob board. If there is no exhaust fan the height should not be less than 70 cm.

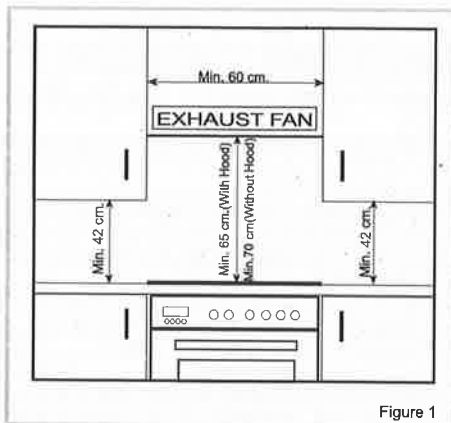
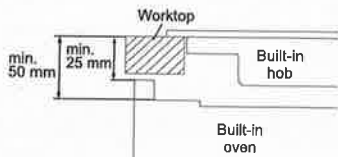
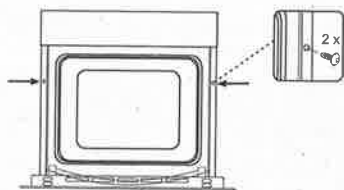
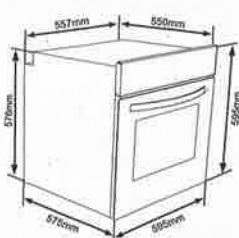
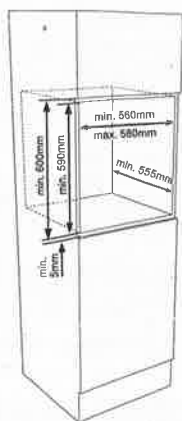
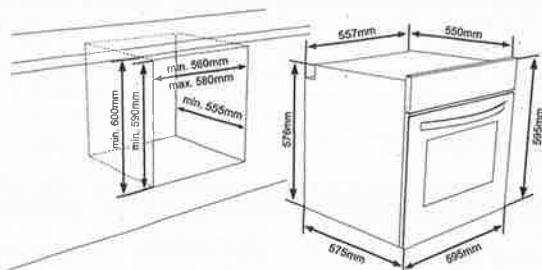

Figure 1

3.2. INSTALLATION OF BUILT-IN OVEN



Insert the oven into the cabinet by pushing it forward. Open the oven door and insert 2 screws in the holes located on the oven frame. While the product frame touches the wooden surface of cabinet, tighten the screws.

If the oven is installed under a hob the distance between the worktop and the top panel of the oven must be minimum 50 mm and the distance between the worktop and the top of control panel must be minimum 25 mm.

The dimensions and material of the cabinet in which the oven will be installed must be correct and resistant to increases in temperature. In a correct installation, contact with electrical or insulated parts must be prevented. Insulating parts need to be fitted in a way to ensure that they cannot be removed by using any kind of tool. Installing the appliance in the close vicinity of a refrigerator or a deep-freezer is not recommended. Otherwise, the performance of the above-mentioned appliances will be negatively affected due to emanating heat. After removing your oven from its packaging, be sure that the oven is not harmed. In case, you suspect of any damage to the appliance, do not use it; immediately contact Authorized Service.

3.3. WIRING AND SAFETY OF BUILT-IN OVEN

The instructions given below must be followed without fail during wiring :

- The earthing cable must be connected via the screw with the earthing mark. Supply cable connection must be as shown in Figure 6. If there is no earthed outlet conforming to regulations in the installation environment, call the Authorized Service immediately.
- The earthed outlet must be in close vicinity of the appliance. Never use an extension cord.
- The supply cable should not contact the product's hot surface.
- In case of any damage to the supply cable, make sure to call the Authorized Service. The cable must be replaced by the Authorized Service.
- Wiring of the appliance must be performed by the Authorized Service. H05VV-F type supply cable must be used.
- Faulty wiring may damage the appliance. Such a damage will not be covered under the warranty.
- The appliance is designed to connect to 220-240V~ electricity is different than the value given above, call the Authorized Service immediately.

The Manufacturer Firm declares that it bears no responsibility whatsoever for any kind of damage and loss arising from not complying with safety norms!

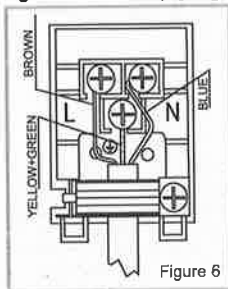
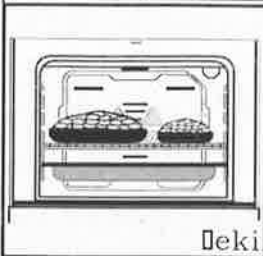

Figure 6



Defrost Function



The oven's warning lights will be turned on, the fan starts operating.

To use the defrost function, take your frozen food and place it in the oven on a shelf placed in the third slot from the bottom. It is recommended that you can place an oven tray under the defrosting food, to catch the water accumulated due to melting ice. This function will not cook or bake your food, it will only help to defrost it.

deki



Turbo Function

The oven's thermostat and warning lights will be turned on, the ring heating element and fan will start operating.

The turbo function evenly disperse the heat in the oven. All foods on all racks will be cooked evenly. It is recommended to pre-heat the oven about 10 minutes.



Static Cooking Function

The oven's thermostat and warning lights will be turned on, the lower and upper heating elements will start operating.

The static cooking function emits heat, ensuring even cooking of the lower and upper food. This is ideal for making pastries, cakes, baked pasta, lasagne and pizza. Preheating the oven for 10 minutes is recommended and it is best to cook on only one shelf at a time in this function.



Fan Function

The oven's thermostat and warning lights will be turned on, the upper and lower heating elements and fan will start operating.

This function is very good for obtaining results in baking pastry. Cooking is carried out by the lower and upper heating element within the oven and by the fan providing air circulation, which will give a slight grill effect to the food. It is recommended to pre-heat the oven about 10 minutes.



Pizza Function

The oven's thermostat and warning lights will be turned on, the ring and lower heating elements and fan will start operating.

Fan and lower heating function is ideal for baking food, such as pizza, equally in a short time. While the fan evenly disperses the heat of the oven, the lower heating element ensures the baking of food dough.



Grill Fonksiyonu :

The oven's thermostat and warning lights will be turned on, the grill heating element will start operating.

The function is used for grilling and toasting foods, use the upper shelves of oven. Lightly brush the wire grid with oil to stop foods sticking and place foods in the center of the grid. Always place a tray beneath to catch any drips of oil or fat. It is recommended to pre-heat the oven about 10 minutes.

Warning: When grilling, the oven door must be closed and the oven temperature should be adjusted to 190°C.



Faster Grilling Function

The oven's thermostat and warning lights will be turned on, the grill and upper heating elements will start operating.

The function is used for faster grilling and for covering a larger surface area, such as grilling meats, use the upper shelves of oven. Lightly brush the wire grid with oil to stop foods sticking and place foods in the center of the grid. Always place a tray beneath to catch any drips of oil or fat. It is recommended to pre-heat the oven about 10 minutes.

Warning: When grilling, the oven door must be closed and the oven temperature should be adjusted to 190°C.

4. USE OF YOUR PRODUCT

Ready Cook is designed on principles such as making amateur users to be able to implement professional recipes easily with auto cooking functions, also allowing housewives to implement their own inspired recipes with combined manual cooking functions. Using a user friendly interface with the help of colored TFT display creates the charm of Ready Cook comparing to existing ovens on the market.

Ready Cook's menus such as manual cooking, auto cooking, favorites, cleaning and settings are described as below.

Manuel Cooking:

Every cooking setting can be set by user in the manuel cooking. 7 different cooking functions, temperature, boost function, cooking duration and cooking end time can be selected. With the flexiability of manual cooking any cooking can be performed by users with respect their own taste.

To perform cooking in the manuel cooking menu, below listed steps should be followed.

On the Main Menu;

- Rotate righth/left the righth knob to navigate between menus .
- Push right knob to select menu.



Oven Function;

- Can be changed by rotating righth knob to righth/left.
- Can be selected by pushing righth knob.



Temperature;

- Can be changed by rotating righth knob to righth/left.
- Can be selected by pushing righth knob.



Boost;

- Can be activated or inactivated by rotating righth knob to righth/left.
- Can be set by pushing righth knob.



4. USE OF YOUR PRODUCT

Cooking duration;

-Can be changed by rotating right knob to right/left.

-Can be selected by pushing right knob.

NOTE: If cooking duration is set as 00:00, cooking continues until user stops manually.



Cooking end time;

-Can be changed by rotating right knob to right/left.

-Can be selected by pushing right knob.

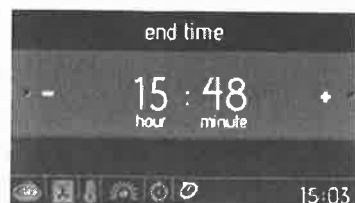

On the information screen;

-Cooking is started within 10 seconds or when right knob is pushed.

-Left knob is rotated left to go back to each previous setting screen



On the animation screen;

-Cooking time,

-Temperature,

-Cooking start & end time,

-Cooking function information is displayed.





Double Grill and Fan Function

The oven's thermostat and warning lights will be turned on, the grill and upper heating elements and fan will start operating.

The function is used for faster grilling of thicker foods and for covering a larger surface area. Both the upper heating elements and grill will be energised along with the fan to ensure even cooking. Use the upper shelves of oven. Lightly brush the wire grid with oil to stop foods sticking and place foods in the center of the grid. Always place a tray beneath to catch any drips of oil or fat. It is recommended to pre-heat the oven about 10 minutes.

Warning: When grilling, the oven door must be closed and the oven temperature should be adjusted to 190°C.



Vap Clean Function

Set your oven function and thermostat to vap clean function symbol. Spill 200-250ml of water (about 1 cup) is stated on the oven base. VapClean run approximately 20 minutes and prepare your oven to clean easily.

Depending on the hardness of the water, base of the product at the end of this study lime stains can occur. To prevent this, the function can be operated by putting water in a shallow pot or small tray.

ENERGY SAVING

- Using a lid will reduce cooking times.
- Minimize the amount of liquid or fat to reduce cooking times.
- When liquid starts boiling, reduce the temperature setting.
- Oven door should not be opened often during cooking period.

4.1 Ready Cook Knob Controls



LEFT KNOB

Long Push: Turn On - Off
Short Push: Pause Cooking
Turn Right: Key Lock
Turn Left: Undo / Go to Previous Menu



RIGHT KNOB

Push: Select / Start Cooking
Turn Right: Menu Navigation/ Increase Temperature
Turn Left: Menu Navigation/ Decrease Temperature



4. USE OF YOUR PRODUCT

On the animation screen;

- Left knob is pushed to stop cooking
- Righth knob is pushed to start and continue cooking.

To stop cooking and go back to main menu, left knob is pushed, then left knob is rotated to left.



Favorites :

At the end of the cooking in the manual cooking menu where cooking duration is set by user, a question as "save to favorites" is displayed on the screen. With the help of this, user can save her/his own cooking settings and repeat the same cooking at any time.

To create the any favorite cooking setting, edit function beneath the favorites menu can be used.

To start any favorite function which is set by user, below listed steps should be followed.

On the main menu;

- Rotate righth/left the righth knob to navigate between menus.
- Push righth knob to select menu.



Favorites;

- Can be changed by rotating righth knob to righth/left.
- Can be selected by pushing righth knob.
- Information about settings of the selected favorite is displayed at the below list.

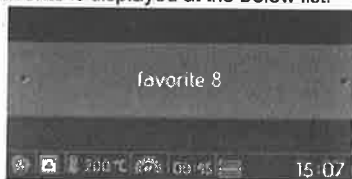

4. USE OF YOUR PRODUCT

On the run/edit screen;

- By rotating right knob to right/left, run/edit can be navigated.
- Run can be selected by pushing right knob.



Cooking end time;

- Can be changed by rotating right knob to right/left.
- Can be selected by pushing right knob.



On the information screen;

- Cooking is started within 10 seconds or when right knob is pushed.
- Left knob is rotated left to go back to each previous setting screens.
- To achieve best cooking performance, tray should be placed to displayed shelf.



On the animation screen;

- Left knob is pushed to stop cooking
- Right knob is pushed to start and continue cooking.

To stop cooking and go back to main menu, left knob is pushed, then left knob is rotated to left.



4. USE OF YOUR PRODUCT

On the animation screen;

- Left knob is pushed to stop cooking
- Right knob is pushed to start and continue cooking.
- Temperature can be changed by rotating right knob to right/left.
- While any cooking function is activated, left knob is rotated left to go to setting screens in order of oven function, temperature and cooking time screens.

To stop cooking and go back to main menu, left knob is pushed, then left knob is rotated to left.



Auto Cooking:

Pre determined recipes which are prepared by professional cooks can be used by end user with auto cooking menu. In auto cooking menu, only name of the meal is selected by user, every cooking settings like cooking function, duration, temperature is set by Ready cook automatically.

To perform cooking with auto cooking menu, below mentioned steps should be followed.

On the main menu;

- Rotate right/left the right knob to navigate between menus.
- Push right knob to select menu.



Food categories;

- Can be changed by rotating right knob to right/left.
- Can be selected by pushing right knob.



4. USE OF YOUR PRODUCT

Food names;

- Can be changed by rotating righth knob to righth/left.
- Can be selected by pushing righth knob.

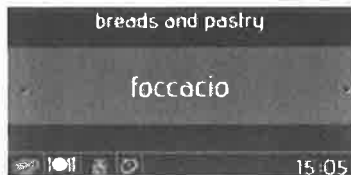

Food weight;

- Can be changed by rotating righth knob to righth/left.
- Can be selected by pushing righth knob



Cooking end time;

- Can be changed by rotating righth knob to righth/left.
- Can be selected by pushing righth knob



On the information screen;

- Cooking is started within 10 seconds or when righth knob is pushed.
 - Left knob is rotated left to go back to each previous setting screens..
- To achive best cooking performance, tray should placed to displayed shelf.



4. USE OF YOUR PRODUCT

To edit any favorite, below listed steps should be followed

On the main menu;

- Rotate righth/left the righth knob to navigate between menus.
- push righth knob to select menu



Favorites;

- Can be changed by rotating righth knob to righth/left.
- Can be selected by pushing righth knob.
- Information about settings of the selected favorite is displayed at the below list.

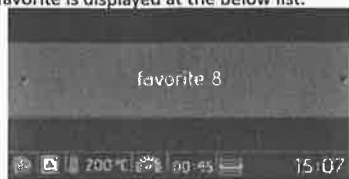

On the run/edit screen;

- By rotating righth knob to righth/left, run/edit can be navigated.
- Edit can be selected by pushing righth knob



Oven function;

- Can be changed by rotating righth knob to righth/left.
- Can be selected by pushing righth knob.



Temperature;

- Can be changed by rotating righth knob to righth/left.
- Can be selected by pushing righth knob.



Boost;

- Can be activated or inactivated by rotating righth knob to righth/left.
- can be set by pushing righth knob.

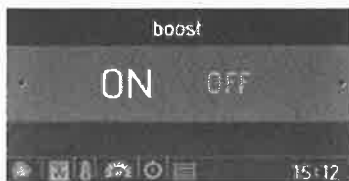

4. USE OF YOUR PRODUCT

Cooking duration;

- Can be changed by rotating righth knob to righth/left.
- Can be selected by pushing righth knob.



Oven shelf;

- Can be changed by rotating righth knob to righth/left.
- Can be selected by pushing righth knob.
- To achieve same cooking performance at each cooking, oven shelf information is important.



On the information screen;

- Left knob is rotated left to go back to each previous setting screens.



Save to favorites;

- Can be navigated between save /cancel by rotating righth knob to righth/ left. can be selected by pushing righth knob.



Cleaning:

With Vapclean function, dried food leftovers inside the oven cavity is softened with vapor. To perform Vapclean, a glass of water is poured into the oven shelf which will be placed at the bottom of the oven.

To perform Vaplean, below listed steps should be followed.

To edit any favorite, below listed steps should be followed.

On the main menu;

- Rotate righth/left the righth knob to navigate between menus.
- Push righth knob to select cleaning menu.



On the function selection screen;

Righth knob is pushed to select Vapclean.

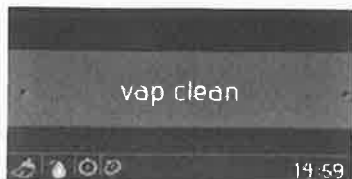

Cleaning duration;

- Can set between 30 – 60 minutes by rotating righth knob to righth/left.
- can be selected by pushing righth knob



Cleaning end time;

- Can be changed by rotating righth knob to righth/left.
- can be selected by pushing righth knob.

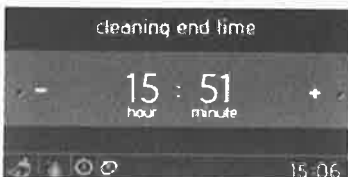

On the information screen;

- Cleaning is started within 10 seconds or when righth knob is pushed.
- Left knob is rotated left to go back to each previous setting screens.

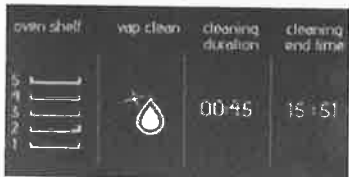

On the animation screen;

- Left knob is pushed to stop cleaning
- Righth knob is pushed to start and continue cleaning.
- To stop cleaning and go back to main menu, left knob is pushed, then left knob is rotated to left.



Settings:

On the settings menu, date, time, screen brightness, buzzer tone, language options can be set.

On the main menu;

- Rotate right/left the right knob to navigate between menus.
- Push right knob to select settings menu.



On the languages menu;

- Languages can be changed by rotating right knob.
- Language can be set by pushing right knob.



On the brightness menu;

- Screen brightness can be changed between 0 – 4 by rotating right knob.
- Screen brightness can be selected by pushing right knob.



On the date menu;

- Date can be changed by rotating right knob.
- Date can be set by pushing right knob.
- Date is set in order of month, day, year.



On clock menu;

- Can be navigated by rotating right knob.
- Time can be set by pushing right knob.
- Time is set in order of minute and hour.



On the buzzer tone menu;

- By rotating righth knob, 3 different tone settings can be navigated.
- Buzzer tone can be set by pushing righth knob.



On the software version menu;

Only software version is displayed as information.

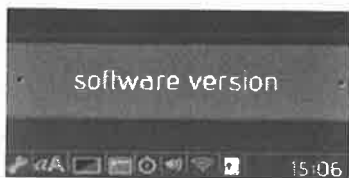

Key Lock:

Key lock is used for to avoid changing settings of the oven unintentionally. To activate or inactivate the key lock, left knob is rotated left for 3 seconds.

When key lock is activated, only "ON/OFF" button can be activated, but other buttons are not.

4.8. ACCESSORIES USED IN THE OVEN

It is recommended that you use the containers indicated on the table depending on the food you will cook in your oven, you can also use glass containers, cake cutters, special oven trays suitable for use in your oven, available in the market. Pay attention to the information given by the manufacturer firm concerning this issue. If small sized containers are used, place this container on the inner grill wire so it will be precisely on the middle of the wire. The information given below should be implemented for enamelled containers.

If the food to be cooked does not completely cover the oven tray, if the food is taken out of the deep-freezer or if the tray is used to collect the dripping juices of the foods during the grill operation; deformation might be observed on the tray due to high temperatures forming during the cooking/frying operation. This is normal, physical state that results during the heat transfer. Do not leave a glass tray or container in a cold environment immediately after cooking in them. Do not place them on cold and wet surfaces. Ensure that they slowly cool off placing them on a dry piece of cloth. Otherwise, the glass tray or container might break. If you are going to perform a grill operation in your oven, we recommend that you use the grill on tray, supplied together with your product (if your product includes this equipment). This way, splattering and dripping oils will not make the oven interior dirty. If you are going to use the large wire grill, insert a tray into one of the lower racks to avoid accumulation of the oils. To make cleaning easier, add some water into it as well. In a grilling operation, use the 3. Or the 4.rack and all the grill to prevent the food to be grilled from sticking to the grill.

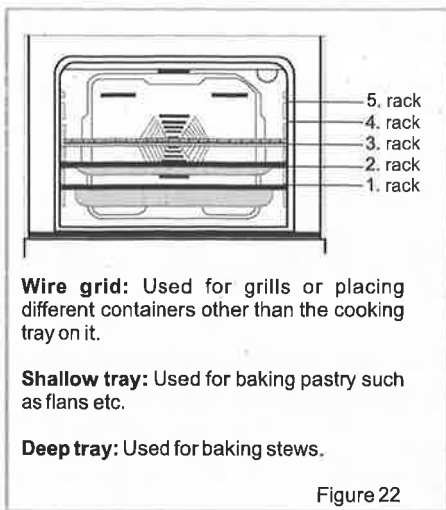

Rotisserie

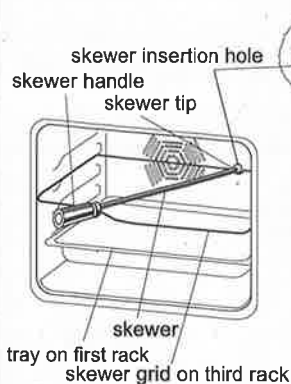

Use of rotisserie accessories

Pass the skewer through the chicken and lock the clamps, insert the tip of the skewer into the hole found at the rear panel of cavity and make sure that it completely leans on the frame and fits in motor shaft. To do this, first you have to turn the lid to the side, which is found in front of the skewer insertion hole, as shown in the figure. After that, fit the skewer onto the skewer grid which you will place on the third rack. Remove the handle from skewer, if it is installed and close the oven door. The handle must be attached only for removing the food after grilling.

Make sure that the oven is not operating while performing these operations.

Wire grid

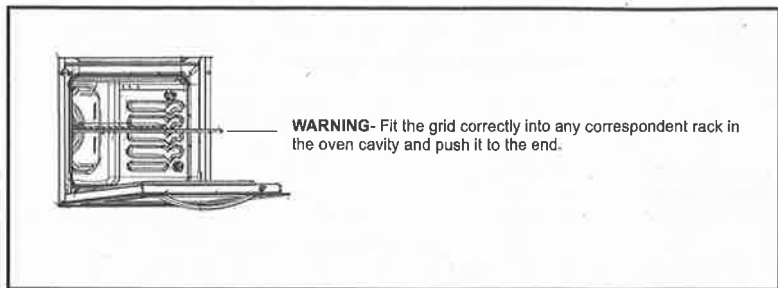
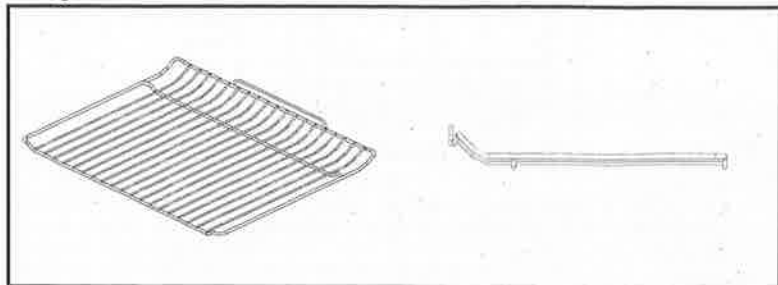

WARNING- Fit the grid correctly into any correspondent rack in the oven cavity and push it to the end.

Removal of wire shelf

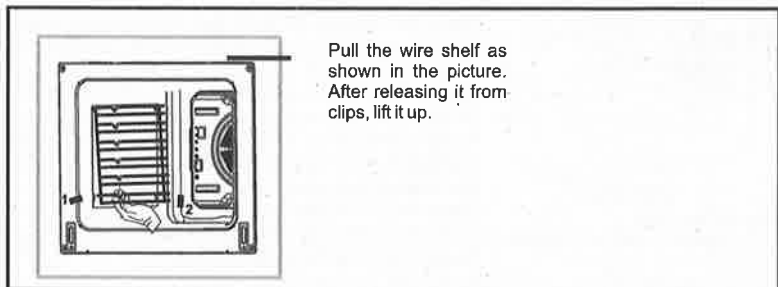

Pull the wire shelf as shown in the picture. After releasing it from clips, lift it up.

PART 5: CLEANING AND MAINTENANCE OF YOUR OVEN

5.1. CLEANING

Before starting to clean your oven, be sure that all control buttons are off and your appliance is cooled off. Unplug the appliance.

Do not use cleaning materials containing particles that might scratch the enamelled and painted parts of your oven. Use cream cleaners or liquid cleaners, which do not contain particles. As they might harm the surfaces, do not use caustic creams, abrasive cleaning powders, rough wire wool or hard tools. In the event the excess liquids spilling over your oven should burn, it may cause a damage to the enamel. Immediately clean up the spill liquids. Do not use steam cleaners for cleaning the oven.

Cleaning the interior of the oven

Make sure to unplug the oven before starting to clean it. You will obtain best results if you clean the oven interior while the oven is slightly warm. Wipe your oven with a soft piece of cloth dampened with soap water after each use. Then wipe it again, this time with a wetted cloth, and wipe it dry. A complete cleaning using dry and powder type cleaners. For product with catalytic enamel frames, the rear and side walls of the inner frame do not require cleaning. However; depending on usage, it is recommended that you replace them after a certain period of time.

5.2. MAINTENANCE

Replacing the Oven Light

The change of oven lamp must be done by authorized technician. The rating of the bulb should be 230V, 25Watt, Type E14, T300 before changing the lamp, the oven should be plugged off and it should be cool.

The lamp design is specific for the use in household cooking appliances and it is not suitable for household room illumination.

PART 6: SERVICE AND TRANSPORT

6.1. REQUIREMENTS BEFORE CONTAINING TO SERVICE

If the oven does not operate :

The oven may be plugged off, there has been a black out. On models fitted with a timer, time may not be regulated.

If the oven does not heat :

The heat may be not adjusted with oven's heater control switch.

If the interior lighting lamp does not light :

The electricity must be controlled. It must be controlled whether the lamps are defective. If they are defective, you can change them as following the guide.

Cooking (if lower-upper part does not cook equally) :

Control the shelf locations, cooking period and heat values according to the manual.

Except these, if you still have any problem with your product, please call to the "Authorized Service".

6.2. INFORMATION RELATED TO TRANSPORT

If you need any transport :

Keep the original case of product and carry it with its original case when need to be carried. Follow the transport signs on case. Tape the cooker on upper parts, hats and heads and saucepan carriers to the cooking panels.

Place a paper between the upper cover and cooking panel, cover the upper cover, than tape to the side surfaces of oven.

Tape carboard or paper onto the front cover on interior glass of oven as it will be suitable to the trays, for the wire grill and trays in your oven not damage to the oven's cover during transport. Also tape the oven's covers to the side walls.

If does not have the original case :

Take measure for external surfaces (glass and painted surfaces) of oven against possible blows.

Brand		
Model		SMART
Type of Oven		ELECTRIC
Mass	kg	34,3
Energy Efficiency Index - conventional		106,0
Energy Efficiency Index - fan forced		94,6
Energy Class		A
Energy consumption (electricity) - conventional	kWh/cycle	0,93
Energy consumption (electricity) - fan forced	kWh/cycle	0,83
Number of cavities		1
Heat Source		ELECTRIC
Volume	l	78
This oven complies with EN 60350-1		

Energy Saving Tips

Oven

- Cook the meals together, if possible.
- Keep the pre-heating time short.
- Do not elongate cooking time.
- Do not forget to turn-off the oven at the end of cooking.
- Do not open oven door during cooking period.



Great Treasure (Building Supplies & Engineering) Limited
長富(建材及工程)有限公司

顧客服務中心 :

香港九龍觀塘偉業街221號美德工業大廈10樓E座

Customer Service Centre : Block E, 10/F., Mai Tak Industrial Building, 221 Wai Yip Street, Kwun Tong, Kln., H.K

電話 Tel.: (852) 3752 6111

傳真 Fax : (852) 2722 1856

www.cristal.com.hk



The symbol on the product or on its packaging indicates that this product may not be treated as household waste. Instead it shall be handed over to the applicable collection point for the recycling of electrical and electronic equipment. By ensuring this product is disposed of correctly, you will help prevent potential negative consequences for the environment and human health, which could otherwise be caused by inappropriate waste handling of this product. For more detailed information about recycling of this product, please contact your local city office, your household waste disposal service or the shop where you purchased the product.

52286924